

50 Jahre Weilrod

Geschichte einer Großgemeinde

Geschichtsverein Weilrod .V.

Was erwartet Sie heute Abend?

01

DATEN, ZAHLEN,
FAKTEN
ZUM BUCH

02

BLICK AUF
50 JAHRE WEILROD
VERSCHIEDENE
BLICKWINKEL

03

UNSERE
13 ORTSTEILE
AUTOREN
BERICHTEN VON
IHRER ARBEIT

Zahlen, Daten, Fakten

- 12 AutorenInnen
- 2 LektorInnen
- 1.120 iger Auflage
- 22 Kapitel
- 245 Bilder
- 91.932 geschriebene Wörter
- Reine Umsetzung von 10/2018 bis 04/2022

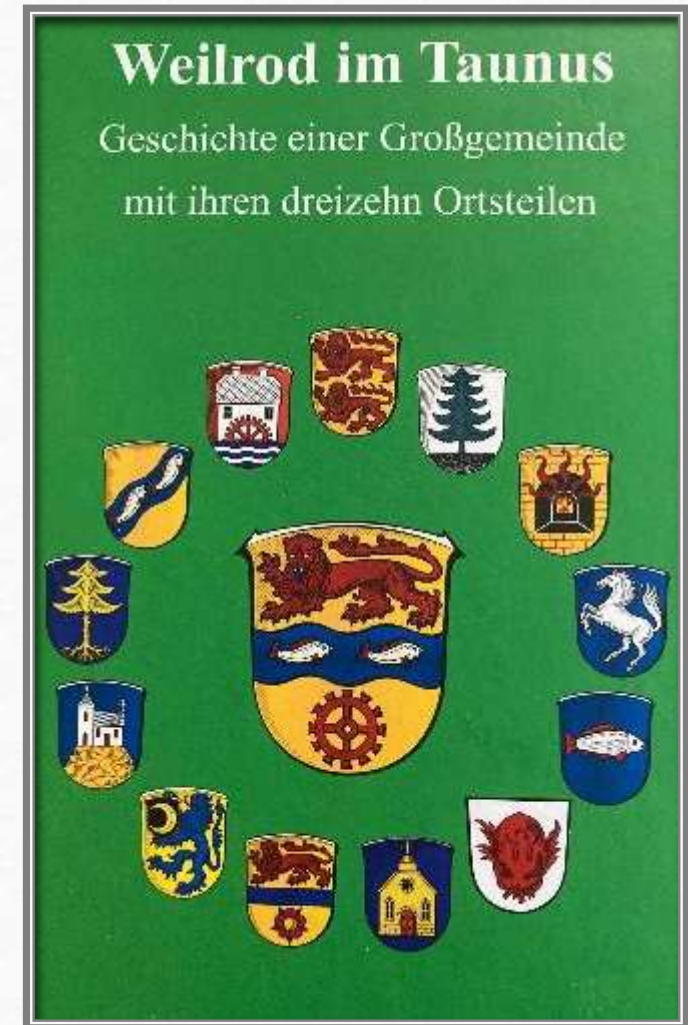

Über die Entstehung

- Grundlage des Buches war das 1987 erschienene Geschichtswerk des Ehepaars Kaethner zur Weilroder Geschichte bis 1972
- Buch ist seit Jahren ausverkauft
- Zunächst Planung für eine Neuauflage mit Korrekturen
- Später sollte ein Buch zum 40. jährigen Jubiläum entstehen
- Bedingt durch Pandemie Veröffentlichung mit 2 jähriger Verzögerung

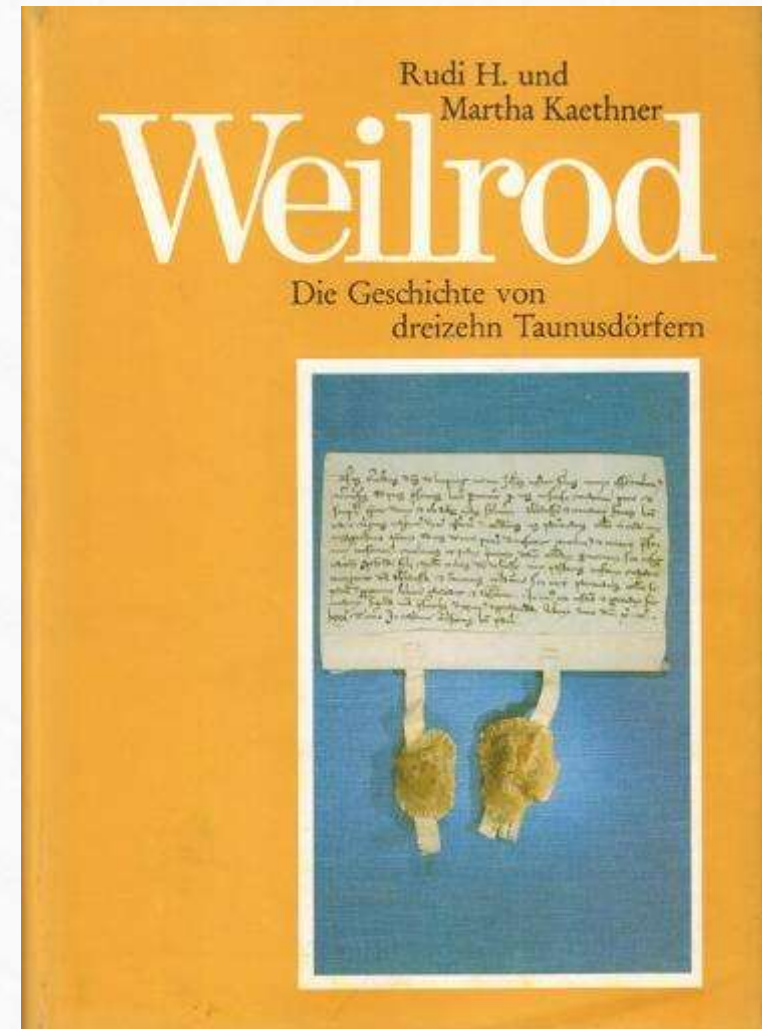



Schwerpunkte



- Gebietsreform 1972 und Gründung der Gemeinde Weilrod
- Blick auf die Frühgeschichte von Weilrod
- Allgemeine Themen aus 50 Jahren Ortsgeschichte
- Tourismus
- FeuerWehren
- Überörtliches
- Beleuchtung aller 13 Ortsteile nach den Schwerpunkten
 - Entwicklung des Ortes
 - Kulturdenkmäler
 - Ortsvorsteher
 - Vereine
 - Kirchliches und Schulwesen





Gebietsreform und Gründung am 11.07.1972

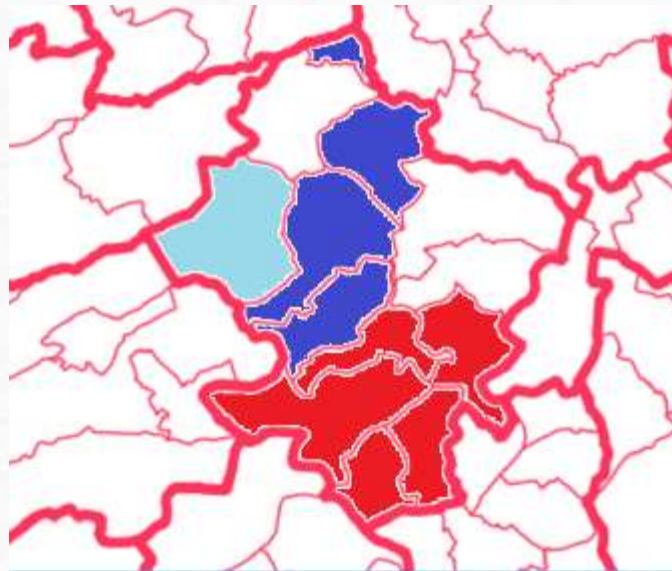

Zwischenstand der Gebietsreform
31.12.1971

- Rot seit 1970: Gemeinde Weilnau mit Alt- und Neuweilnau, Riedelbach, Finsterthal und Mauloff
- Blau: Rod an der Weil, Winden, Cratzenbach und Gemünden
- Hellblau: Hasselbach umstrittener Ort (man wünschte sich die Eingemeindung zu Rod, doch Kreis Limburg stimmte nicht zu)
- Dicke rote Linie: heutige Gemeindegrenzen

Überörtliches aus Weilrod

- Taunusmafia
- “Eventlocations”
Mappes + Erbismühle
- Persönlichkeiten
- Corona und die Folgen



Übersicht und kleines Quiz

- Bevölkerungsentwicklung
Wie viele Einwohner hat Weilrod?
- Erhebungen in Weilrod
Wie heißt der höchste Berg in Weilrod?
- Natur- und Kulturdenkmäler
Kennen Sie die Höhle „Josef III“?
- Zuflüssen und Nebenbächen
Wie viele Nebenflüsse hat die Weil auf Weilroder Gebiet?
- Ehemalige Bergwerke
Was wurde in den Gruben mehrheitlich abgebaut?
- Ruhebänke
Wie viele Ruhebänke stehen in Weilrod zur Verfügung?
- Feuerwehrstatistik
Wie viele Personenstunden wurden 2021 aufgewendet?

6624

Mehlbusch,
625,7 m

Hasselbach

18

Silberhaltig
es Bleierz

554

2474

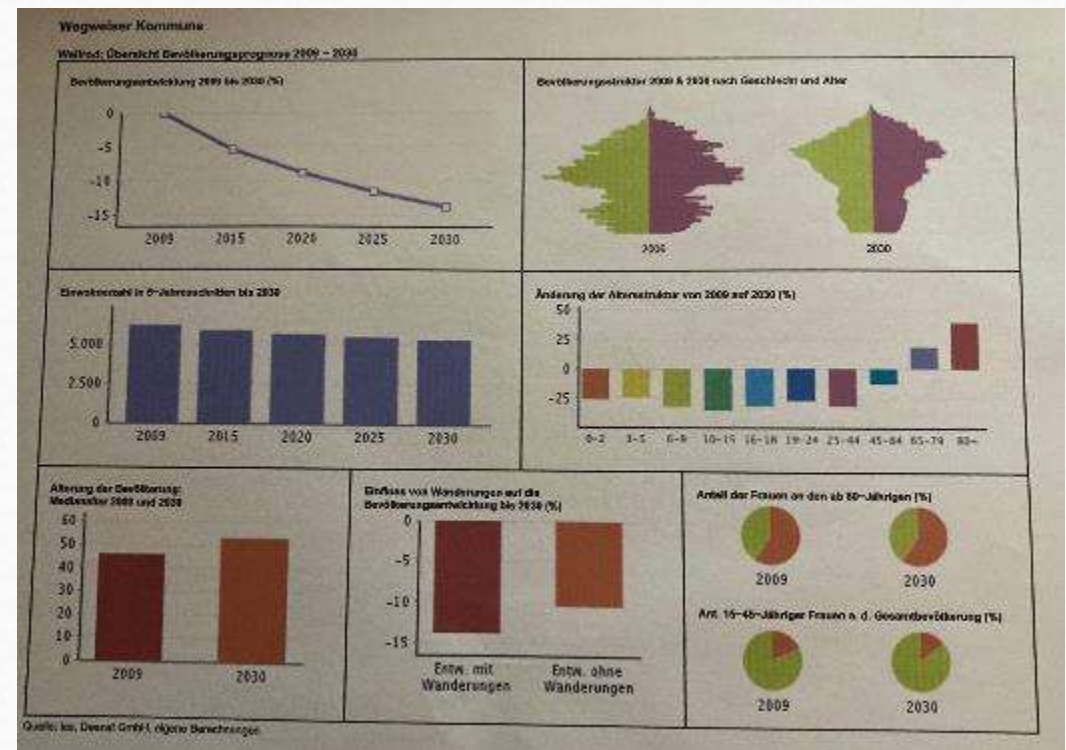



Die 5 Ws

- **W**andel – Demografischer Wandel, Bautätigkeiten, Digitalisierung
- **W**ald – HessenForst, Friedwald, Klimawandel
- **W**eil – Trinkwasser, Brunnen, Staudamm, Schwimmbäder
- **W**indkraft – Bau, in Betriebnahme und Nutzung
- **W**iesen und Felder – Veränderung der Landwirtschaft

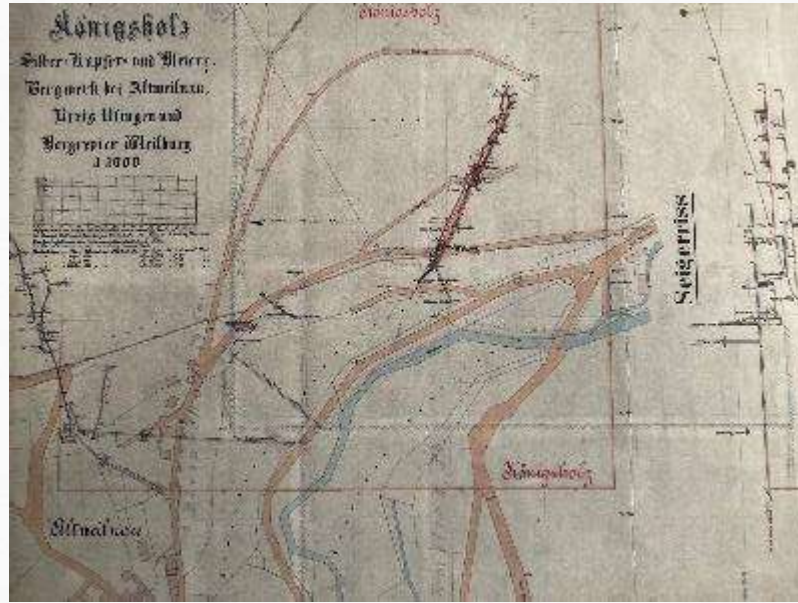

Touristische Aktivitäten



Weilrod in Funk und Fernsehen

Tatort: Filmdreh



Dolles Dorf



Unsere Weilroder Wehren

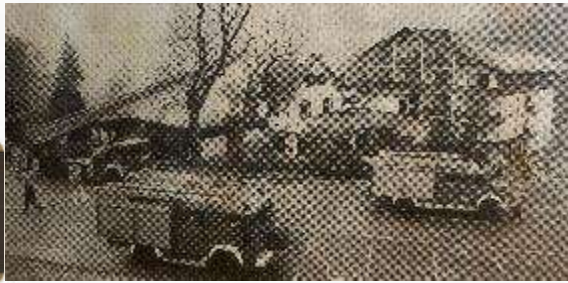

Das fand leider keinen Platz mehr ...

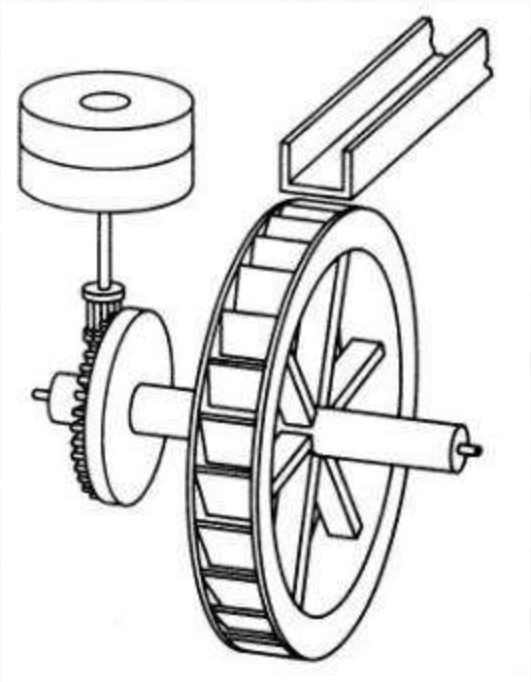

Unsere 13 Ortsteile

Anwesende Autoren berichten über ihre
Arbeit zur Ortsgeschichte





Altweilnau

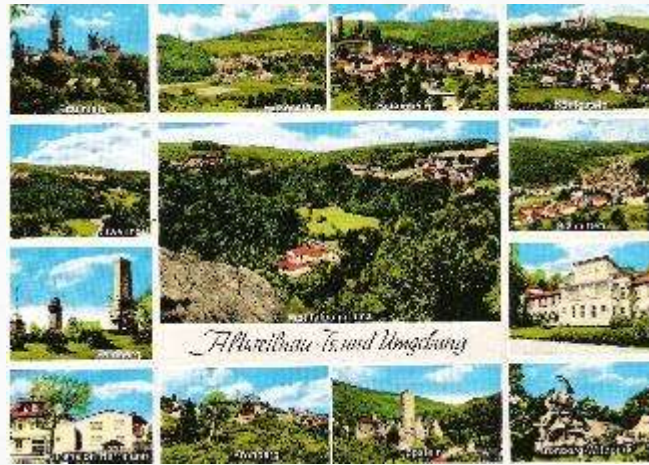

Blick vom Burg-Restaurant Altweilnau im Taunus



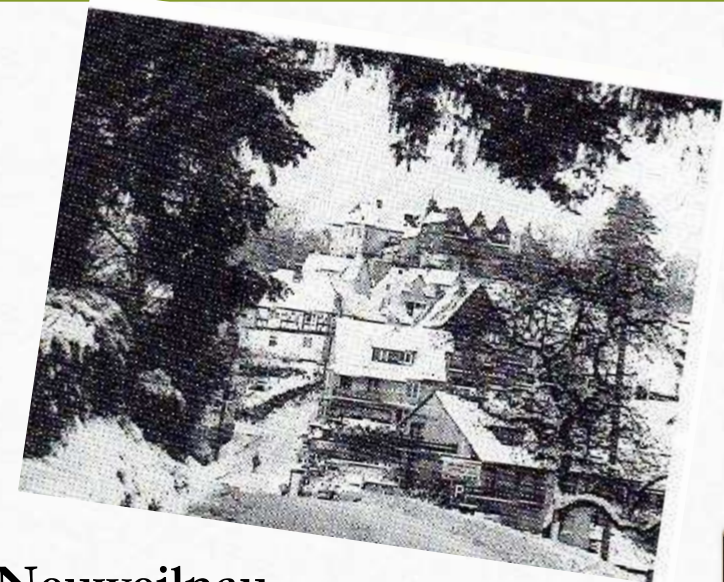
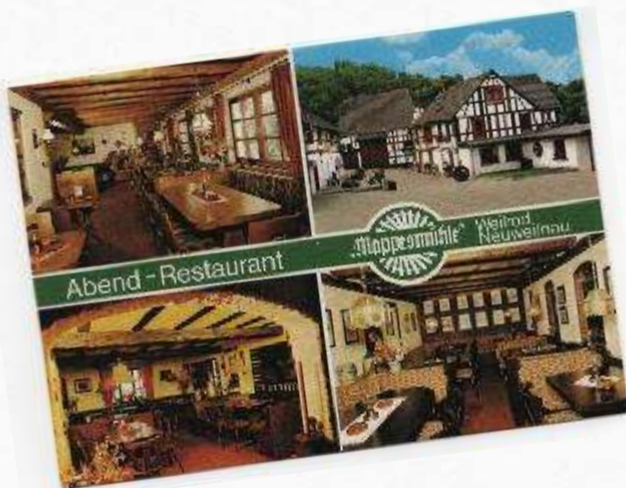

Neuweilnau

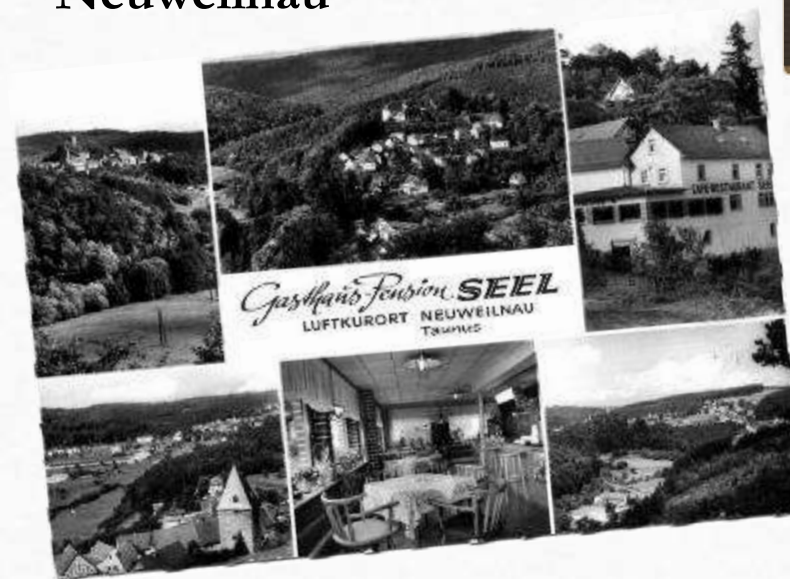



Riedelbach



Finsternthal



Mauloff,
höchstgelegener Ort in Weilrod



**Cratzenbach
ältester Ort in
Weilrod**

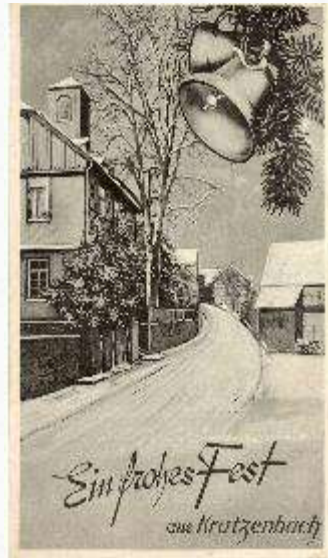



Hasselbach



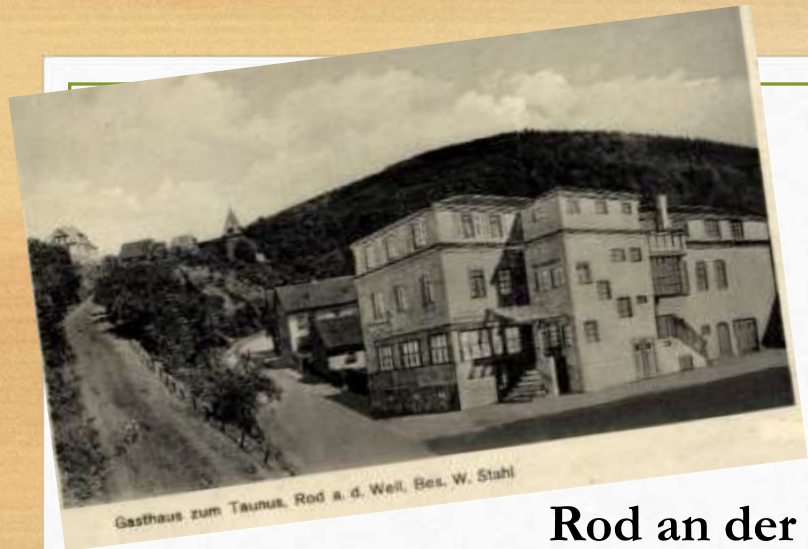

Gasthaus zum Taunus, Rod a. d. Weil, Bes. W. Stahl



Runkelsteiner Mühle im Taunus
Post ROD a. d. Weil
Besitzer Albert Müller



Runkelsteiner
Mühle

Gaststätte
Pension
Café
im Weiltal

Rod an der Weil
Ziegelhütte
Runkelsteiner Mühle
Gasthaus Waldlust

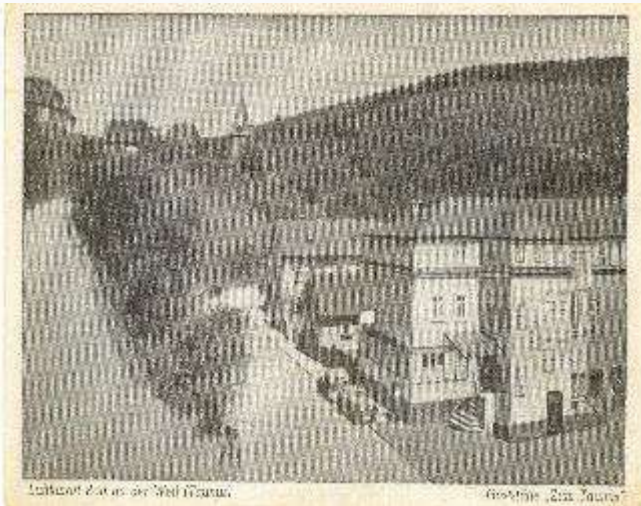

Waldlust Rod an der Weil Taunus



Pension Ziegelhütte, Rod a. d. Weil, Taunus





Emmerhäuser Mühle



Winkel, Winden über Illingen



Gemünden / Touring

Volksgemeinschaftshaus



Emmerhäuser Mühle
Blick vom Schwimmbad

Emmershausen

Winden



Gaststätte Pension Burck-Hof



Gasthaus Pension Zur Linde
Gemünden / Touring

Gemünden



Oberlauken

Niederlauken

Der Dank gebührt allen Beteiligten, die zum Gelingen des Buches beigetragen haben.
Danke für die **Hingabe**, **Akribie** und **Zeit**, die von jedem einzelnen investiert wurde!



Axel Bangert
Erwin Buhlmann
Gundi Eschenröder
Wolfgang Ettig
Thomas Götz
Wolfgang Haub
Karl-Otto Kilb
René Landsee
Peter Maresch
Karin Müller
Sabine Neugebauer
Sabine Preußner
Prof. Dr. Horst Seibert
Herbert Wischmann